

Copyright © 2007, QVF Engineering GmbH. All rights reserved.



RESISTANCE THERMOMETER FOR EX AREAS

Certificate: ATEX II 1 GD EEx ia IIC

These devices consist of a resistance thermometer with stainless steel protective tube (M-THR3...) and, for the M-THR6..., an additional protective sleeve made of borosilicate glass 3.3. The glass protective tube is filled with heat conducting paste for better heat exchange.

The resistance thermometers can be installed with GL threaded fittings.

Technical data

Measuring insert	Measurement resistance	- 1x Pt 100 as per IEC 751, Class A, 4-conductor
Permitted product	temperature	- 50 to +200 °C
Connecting head	Design	- TA20A Alu
	Cable socket	- M20 x 1.5 blue
Measuring transducer (only for type: THRXT)	Measuring range	- 50 up to +200 °C
	Ex protection	- II 1G EEx ia IIC
Output signal		- 4 to 20 mA, 2-conductor
Ex protection	Measuring insert	- II 1G EEx ia IIC

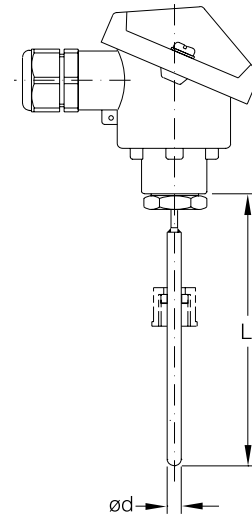

d	L	Type	Reference
3	120	A	M-THR3/120
3	120	B	M-THRXT3/120
6	120	A	M-THR6/120
6	120	B	M-THRXT6/120

Type A: without measuring transducer

Type B: with measuring transducer

RESISTANCE THERMOMETER

These devices consist of a resistance thermometer with stainless steel protective tube (M-THR3/100) and, for the M-THR6/100, an additional protective sleeve made of borosilicate glass. The probe tip is used with heat conducting paste for better heat exchange.

Technical data

Measuring insert	Measurement resistance	- 1x Pt 100 as per IEC 751, Class A, 4-conductor
	Permitted product temperature	- -50 to +200 °C
Connecting cable	Design	- 8 m silicon with free ends

d	L	Reference
3	100	M-THR3/100
6	100	M-THR6/100

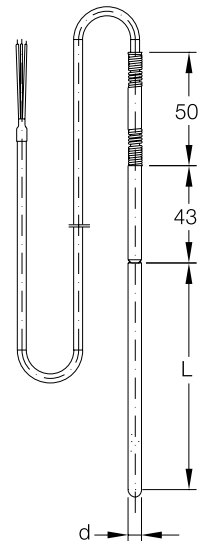

LEVEL SWITCH

This is an opto-electronic sensor that sends timed infrared light into the glass rod. The contact is actuated when the glass rod is dipped into a liquid.

Technical data

Sensor	Supply voltage	- 10 - 30 V DC
	No-load current input	- < 40 mA
	Output type	- Transistor
	Max. switching current PNP	- 200 mA
	Protection type	- IP 67
	Ambient temperature	- -20 to +50 °C

These sensors are not suitable for safety applications.

M-LLSC12... When the glass rod is dipped in, the contact is closed (min.).

M-LLSO12... When the glass rod is dipped in, the contact is opened (max.).

L	L1	d	Type	Reference
150	100	12	opener	M-LLSO12/100
200	150	12	opener	M-LLSO12/150
250	200	12	opener	M-LLSO12/200
350	300	12	opener	M-LLSO12/300
450	400	12	opener	M-LLSO12/400
150	100	12	shutter	M-LLSC12/100
200	150	12	shutter	M-LLSC12/150
250	200	12	shutter	M-LLSC12/200
350	300	12	shutter	M-LLSC12/300
450	400	12	shutter	M-LLSC12/400

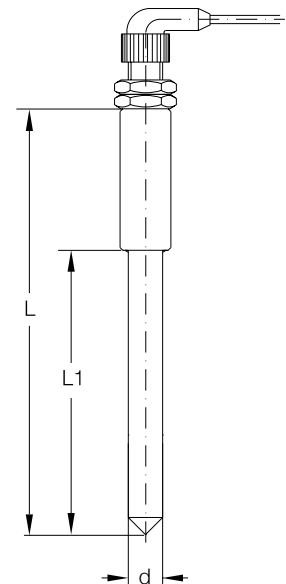

LEVEL SWITCH FOR THE CATAGORY 2G EX AREA

IRD-10P EEx d IIC T6 ATEX

The opto-electronic sensor sends timed infrared light into the glass rod through an optical fiber. The contact is opened when the glass rod is dipped into a liquid.

Technical data

Sensor	Supply voltage	- 20 - 28 V DC
	No-load current input	- < 60 mA
	Output type	- Transistor
	Max. switching current	
	PNP	- 100 mA
	Protection type	- IP 67
	Ambient temperature	- -20 to +50 °C
Accessories	Lenght of optical fiber	- 500 mm
Ex protection	Protection type	- EEx d IIC T6
	ATEX identification code	- DMT 99 ATEX E 056/N1

L	L1	øD	Reference
140	100	12	M-LLSX12/100
190	150	12	M-LLSX12/150
240	200	12	M-LLSX12/200
340	300	12	M-LLSX12/300
440	400	12	M-LLSX12/400

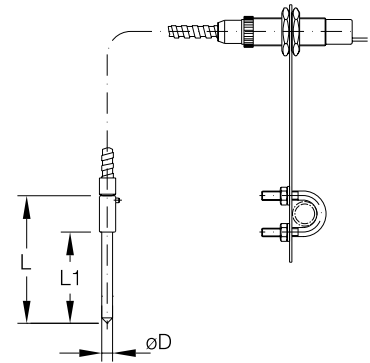

PH/REDOX MEASUREMENT

For wall set-up or cabinet installation, including sensor connecting cable

Technical data

Measurement ranges	- pH -1 ... 14; -1999 ... 1999mV; -50 ... 250 °C
Measurement resolution	- 0,01 pH; 1 mV; 0,1 °C
Temperature compensation	- automatic or manual
Control outputs	- voltage-free relay outputs; max. 3 A, 250 V AC; 1 binary exit
Analogue outputs	- 0 (4) ... 20 mA or 0 (2) ... 10 V
Display	- 2 x 4 position LED display, 13 / 8 mm
Power supply	- 20...53 V AC/DC, approx. 8 VA
Ambient temperature	- -10 ... 55 °C

Wall set-up housing	- Plastic housing for wall set-up with connecting space; protection rating IP65
Dimensions	- 151 x 138 x 170 mm (WxHxD)

Housing for control cabinet installation	- Switchboard installation housing front protection rating IP 65
Dimensions	- 96 x 48 x 106 (WxHxD)
EMC	- EN 61326

Electrodes	- Single-rod measuring cells, separated measuring cells; temperature probe Pt 100 or Pt 1000
------------	--

Cable	- SMEK plug-in head connector, length 8 m.
-------	--

Measurement	Type	Reference
PH/Redox	A	M-MU2000-W
PH/Redox	B	M-MU2000-P

Type A: for field mounting

Type B: for integration into control cabinet

A wall assembling

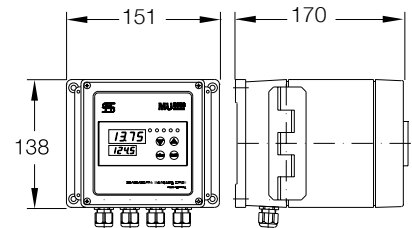

B control rack

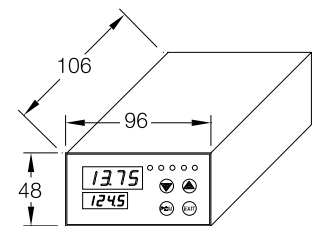

CONDUCTIVITY-MEASUREMENT

For wall set-up or cabinet installation, including sensor connecting cable

Technical data

Measurement ranges	- 0 ... 0.5 mS/cm up to 0 ... 200 mS/cm; -50 ... 250 °C
Measurement resolution	- 0,01 pH; 1 mV; 0,1 °C
Adjustable cell constants	- 0.01; 0.1; 1.0; 3.0; 10.0 cm
Temperature probe	- Pt 100 or Pt 1000
Temperature compensation	- automatic, 0...5.5 %/K
Control outputs	- 2 voltage-free relay outputs; max. 3 A, 250 V AC; 1 binary exit
Analogue outputs	- 0 (4) ... 20 mA or 0 (2) ... 10 V
Display	- 2 x 4 position LED display, 13 / 8 mm
Power supply	- 20...53 V AC/DC, approx. 8 VA
Ambient temperature	- -10 ... 55 °C

Wall set-up housing	- Plastic housing for wall set-up with connecting space; protection rating IP65
Dimensions	- 151 x 138 x 170 mm (WxHxD)

Housing for control cabinet installation	- Switchboard installation housing front protection rating IP 65
Dimensions	- 96 x 48 x 106 (WxHxD)
EMC	- EN 61326

Electrodes	- Single-rod measuring cells, separated measuring cells; temperature probe Pt 100 or Pt 1000
------------	--

Cable	- SMEK plug-in head connector, length 8 m.
-------	--

Measurement	Type	Reference
Conductivity	A	M-MU2020-W
Conductivity	B	M-MU2020-P

Type A: for field mounting

Type B: for integration into control cabinet

A wall assembling

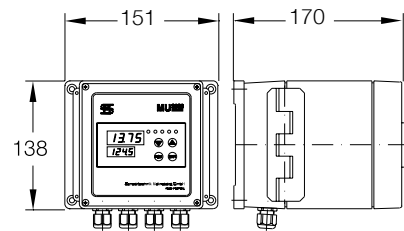

B control rack

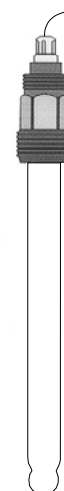
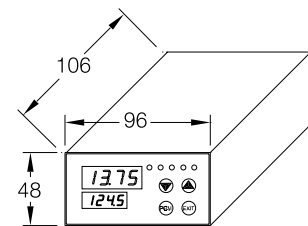

IMPELLER FLOW SENSOR

The compact flow sensor works according to the paddlewheel principle and is especially suitable for use in solid-free and aggressive fluids.

The sensor is supplied with a G 1/4" male thread for the process connection and a 3-lead cable for the electrical connection.

Technical data

Measurement recorder	Operating pressure	- 5 bar, 22 °C
	Protection type	- IP 65
	Viscosity of the media	- 1 ... 10 cst
	Measuring range	- 10 ... 150 l/h
	Accuracy	- 2 % (meas. range limit value)
	Operating voltage	- 12 ... 24 V DC

Materials	Housing	- ECTFE (Halar)
	Vane wheel	- ECTFE (Halar)
	Axle and bearing	- Sapphire
	Magnets	- ECTFE (Halar) encapsulated
	O-ring	- FFKM



The measuring transducer is included in the scope of supply.

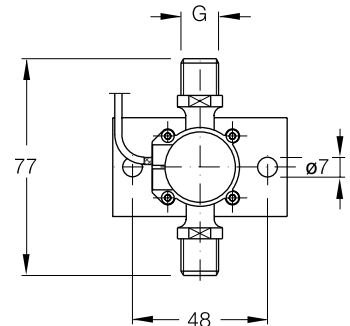

G	Type	Reference
1/4"	wall assembling	M-LFS15-W
1/4"	control rack	M-LFS15-P

Measuring transducer for control cabinet (M-LFS15-P)

The electrical connection is made through terminals. The output signal is an impressed standard signal 4...20mA. The measuring transducer requires a power supply of 13...30 VDC for operation.

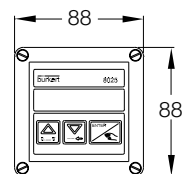

Measuring transducer for field mounting (M-LFS15-W)

The flow transmitter is integrated into a splash-proof plastic housing, protection rating IP 65.

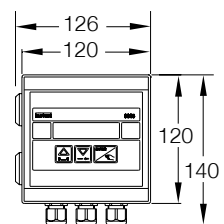

FLOWMETER, SUSPENDED BODY

with threaded connection

A suspended body is carried concentrically by a specially shaped conical tube, and the position of the suspended body is magnetically transmitted to a display.

The devices are used for measuring small flows of liquids and gases.

The flowmeters are to be mounted vertically in a pipeline so that the material to be measured can flow upward through the device.

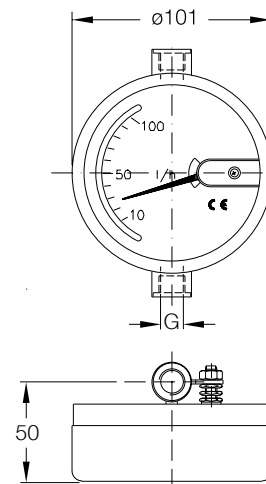

Technical data

Measurement recorder	Measurable forms	- Fluids or gases
	Measuring ranges	- 10 - 100 l/h
	Measuring range ratio	- 10 : 1
	Accuracy	- Class 4 as per VDI/VDE 3513
	Display scale	- Calibrated for water (standard)

Process connection	Material	- Inside thread G 1/4 - All medium-contacting parts are stainless steel (1.4571).
--------------------	----------	--

Measuring transducer	Power supply	- 13.5 - 30 V DC
	Output signal	- 4 - 20 mA

Ex protection	Design	- II 2 G EEx ia IIC T5...T6
---------------	--------	-----------------------------

G	Measure L	Reference
1/4"	125	M-FMT100

FLOWMETER, SUSPENDED BODY

with connecting flange

A suspended body is carried concentrically by a specially shaped conical tube. The position of the suspended body is magnetically transmitted to a display.

The devices are used for measuring small flows of liquids and gases.

The flowmeters are to be mounted vertically in a pipeline so that the material to be measured can flow upward through the device.

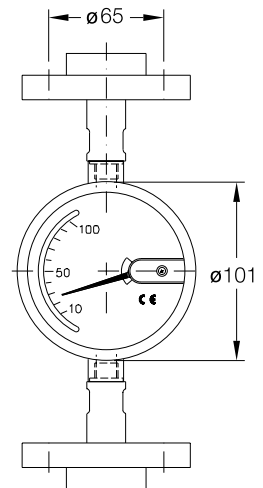

Technical data

Measurement recorder	Measurable forms	- Fluids or gases
	Measuring ranges	- 10 - 100 l/h
	Measuring range ratio	- 10 : 1
	Accuracy	- Class 4 as per VDI/VDE 3513
	Display scale	- Calibrated for water (standard)
Process connection		- Flanges DN ¹⁵ , PN 40
	Material	- All medium-contacting parts are stainless steel (1.4571).
Measuring transducer	Power supply	- 13.5 - 30 V DC
	Output signal	- 4 - 20 mA
Ex protection	Design	- II 2 G EEx ia IIC T5...T6

Measure L	Reference
250	M-FMTF100

DIFFERENTIAL PRESSURE TRANSDUCER

The differential pressure sensor is used to measure pressure differences in columns. The display is not included in the scope of supply.



Threaded connection fittings for 10 mm hose M-EVD10/NPT 1/4".

Technical data

Measurement recorder	Measuring cell	- Ceramic, max. 10 bar Kalrez measuring cell seal
	Measuring range	- 25 mbar
	Output signal	- 4 - 20 mA
	Permitted temp. range	- -40 to 120°C
Housing	Material	- Aluminum
	Process connection	- 1/4" NPT
Ex-Schutzart	Schutzart	- ATEX II 1/2G EEx ia IIC T4/T6

NPT	Reference
1/4"	M-DPGT25

